

## SURFACE MOUNTED

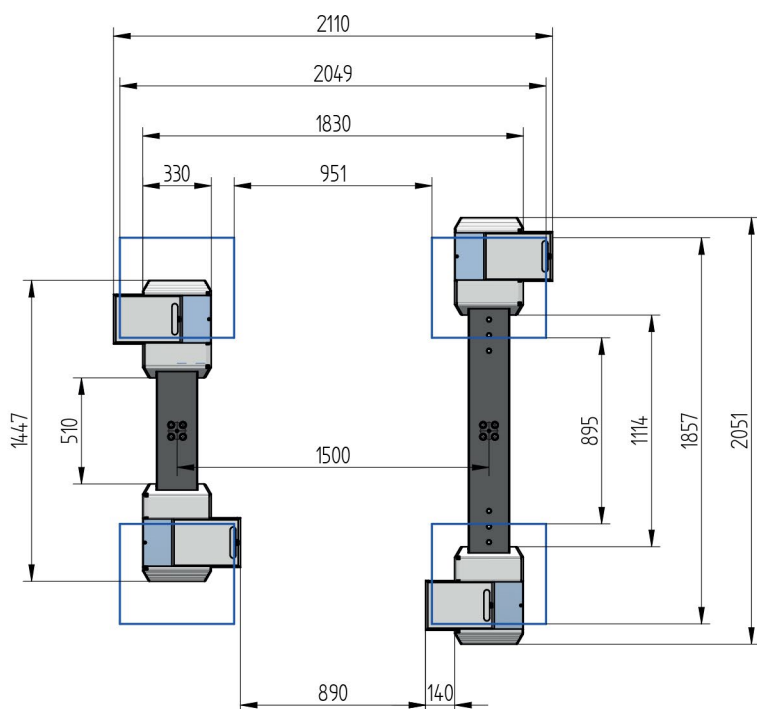
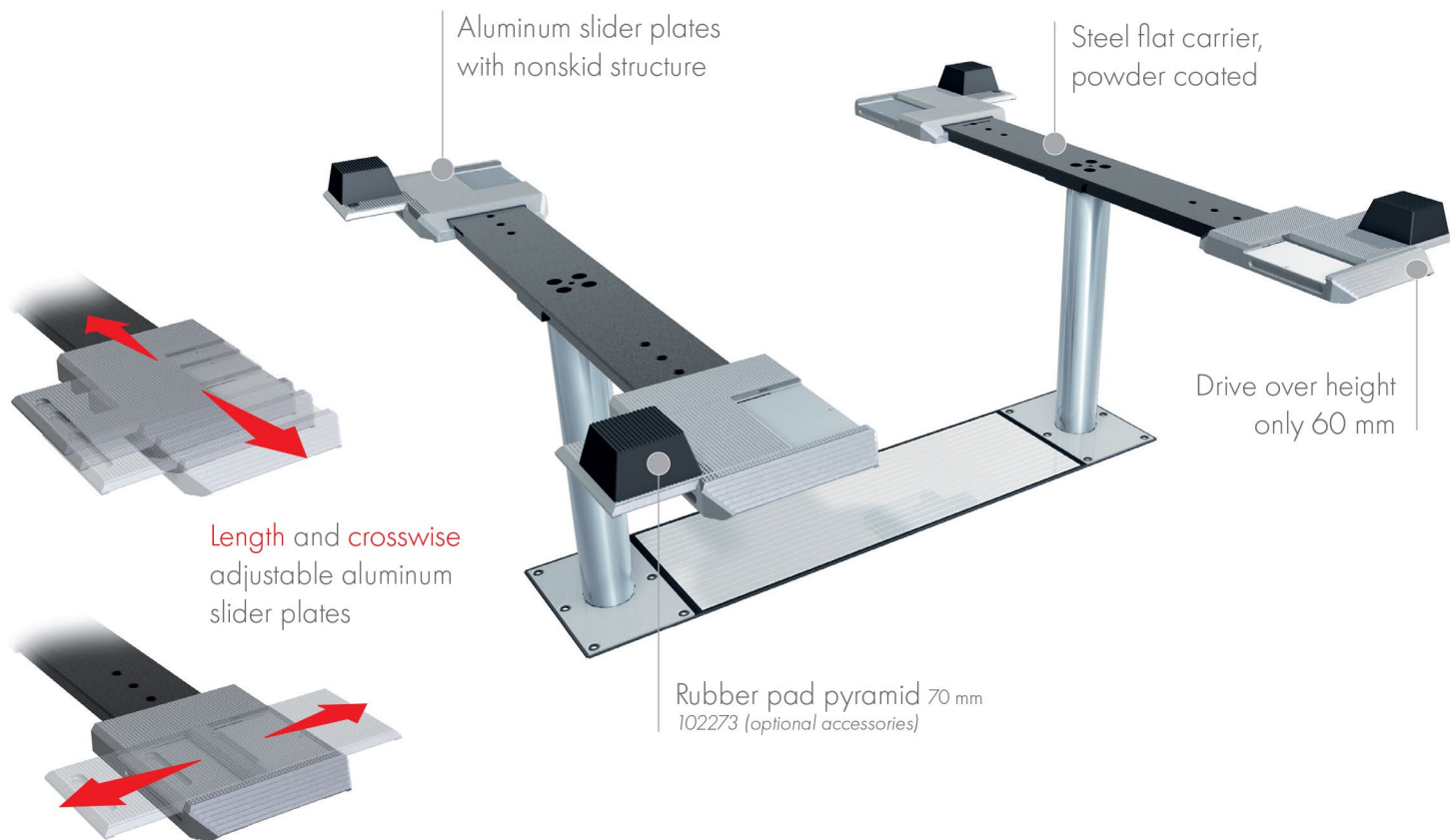

## TECHNICAL DATA

Capacity	3500 kg
Effective raise height	2023 mm
Drive over height	60 mm
Piston diameter	123 mm
Piston distance	1500 mm
Installation depth	2408 mm
Motor output	3,0 kW
Power connector	400 V/16 A
Cable length to control	11 m
Lifting time	≈ 35 sec.
Lowering time	≈ 35 sec.

Support Uni 2.35 plus	102640
Support Uni 2.35 plus galvanized	105217
Installation cassette STEEL 1500 mm	2260XX
Installation cassette STEEL 1500 mm galvanized	2261XX
Lifting unit oil 3,5 t 1500 mm - K pre-assembled in installation cassette	109965
Lifting unit oil 3,5 t 1500 mm - H packed in wooden box	109977



## ACCESSORIES

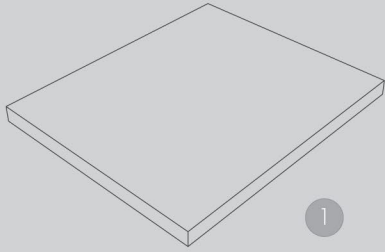

1

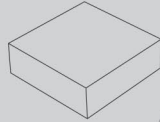

2

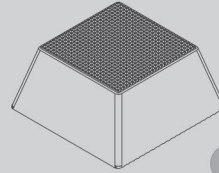

3

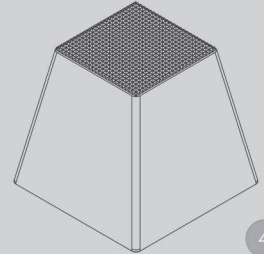

4

1 Rubber pad  
290 x 335 x 20 mm  
102275 (1 Set / 4 Pieces)

2 Rubber pad  
120 x 120 x 40 mm  
102274 (1 Set / 4 Pieces)

3 Rubber pad pyramid  
70 mm  
102273 (1 Set / 4 Pieces)

4 Rubber pad pyramid  
140 mm  
102291 (1 Set / 4 Pieces)

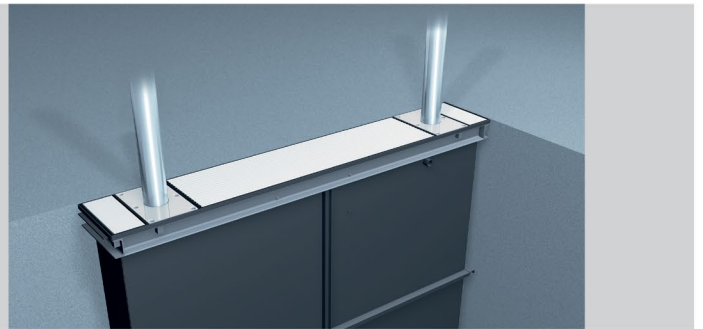
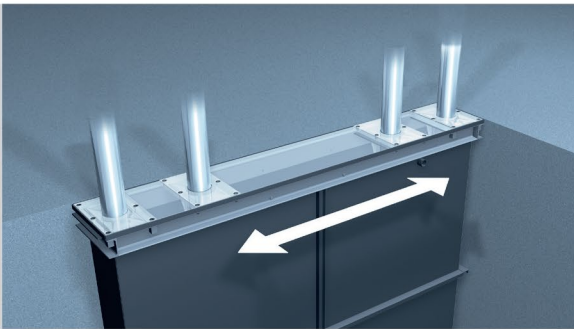

### Future Proof Installation cassette

Steel 2530 mm  
Drilling pattern 2530 / 2285 / 1785 / 1500  
2530XX  
Steel galvanized 2530 mm  
Drilling pattern 2530 / 2285 / 1785 / 1500  
2531XX

### Cover kit for Future Proof Installation cassette

111582