



GRK

READY-KIT

 I kit GRK sono la risposta veloce e immediata per proporre un kit completo di canalina di varia lunghezza con elementi scorrevoli in base alle zone di lavoro da servire. Basta completarli con i materiali per adattarsi all'applicazione (bocchette, staffe di supporto, camino di espulsione, interruttore) e l'impianto è fatto.

Il READY KIT è studiato per servire le zone di lavoro in linea partendo da un minimo di 2 fino ad un massimo di 7... anche se la sua estrema modularità ci permette di ampliarlo secondo necessità. Il prodotto presenta le versioni con carrello scorrevole, arrotolatore scorrevole e il nuovo sistema universale TOUCHLESS (senza contatto col veicolo).

 GRK kits provide a quick answer for proposing complete rail systems of multiple lengths and with sliding elements according to the number of work bays.

You just need to add the variables that best suit the case (nozzles, brackets, chimney, switch) and the system is done! The READY KIT is designed to serve from 2 to 7 work bays in line, even if, thanks to its extreme flexibility, we can extend it as much as required. This product has several versions: with sliding trolleys, with hose reels and with the latest system, the universal GTL TOUCHLESS (contactless solution).

 Les kits GRK constituent une réponse rapide pour desservir les zones de travail par un kit complet avec rails de différentes longueurs et ses éléments coulissants. Il suffit de les compléter avec les composants pour s'adapter à l'application (entonnoirs, brides de support, cheminée d'expulsion, interrupteur) et le système est terminé. Le READY KIT est conçu pour desservir des zones de travail en ligne d'un minimum de 2 à un maximum de 7 ... même si sa modularité extrême nous permet de l'agrandir au besoin. Le produit présente des versions avec chariot coulissant, enrouleur coulissant et le nouveau système universel TOUCHLESS (sans contact avec le véhicule).

 Die GRK-Kits sind die schnellsten und sofortigen Antworten, um ein komplettes Saugschlitzkanal-Set mit verschiedenen Längen mit schlitzbaren Elementen abhängig von Arbeitsbereichen vorzuschlagen. Man braucht nur Projekt spezifisches Elementen hinzufügen (Düsen, Halterungen, Ausblastsatz, Schalter) und die Anlage ist fertig. Das READY KIT ist geeignet für Werkstätte ab 2 bis 7 Arbeitsplätze in einer Reihe, obwohl es aufgrund seiner extremen Modularität möglich ist, es nach Bedarf zu erweitern. Mehrere Ausführungen verfügbar: mit Schlauchwagen, Schlauchaufroller und dem neuen TOUCHLESS-Universalsystem (ohne Kontakt zum Fahrzeug).

 Los kits de GRK son la respuesta rápida e inmediata para proponer un kit completo de varias longitudes con elementos deslizantes según las zonas de trabajo del taller. Simplemente complete con los materiales específicos del proyecto (boqueras, soportes, chimenea, interruptor) y el equipo ya está hecho. El READY KIT está diseñado para servir zonas de trabajo en línea que van desde un mínimo de 2 hasta un máximo de 7 ... aunque su modularidad extrema nos permite expandirlo según necesidad. El producto presenta versiones con carro y enrollador deslizantes y el nuevo sistema universal TOUCHLESS (sin contacto con el vehículo).





GRK1



 Kit completi con canalina, aspiratore, un carrello scorrevole con 7,5m tubo flessibile. Da completare con staffe, bocchetta e camino.

 Complete kits with rail, fan, one sliding carriage with hose 7,5m. To be completed with hanging brackets, nozzle and chimney.

 Kit complet avec rail, ventilateur d'extraction, un chariot roulant avec 7.5 m de tuyau flexible. Kit à compléter avec les étriers de suspension, l'entonnoir, l'interrupteur électrique et le kit de refoulement extérieur.

 Satz mit Saugschlitzkanal, Ventilator und einem Wagen mit 7,5m Schlauch mit Seil mit Ring. Aufhängungen, Trichter und Ausblasrohrleitungen sind nicht inbegriffen.

 Kit completos con carril, aspirador, un carro deslizante con 7,5m de manguera. Para completar con estribos, boqueres y chimenea.

GRK1	Ø / L.	L.	HP
GRK1-75-8	75 mm / 7,5 m	8 m	1,0
GRK1-75-12	75 mm / 7,5 m	12 m	1,0
GRK1-75-16	75 mm / 7,5 m	16 m	1,0
GRK1-75-20	75 mm / 7,5 m	20 m	1,0
GRK1-75-24	75 mm / 7,5 m	24 m	1,0
GRK1-100-8	100 mm / 7,5 m	8 m	1,0
GRK1-100-12	100 mm / 7,5 m	12 m	1,0
GRK1-100-16	100 mm / 7,5 m	16 m	1,0
GRK1-100-20	100 mm / 7,5 m	20 m	1,0
GRK1-100-24	100 mm / 7,5 m	24 m	1,0
GRK1-125-12	125 mm / 7,5 m	12 m	1,5
GRK1-125-16	125 mm / 7,5 m	16 m	1,5
GRK1-125-20	125 mm / 7,5 m	20 m	1,5
GRK1-125-24	125 mm / 7,5 m	24 m	1,5
GRK1-125-28	125 mm / 7,5 m	28 m	1,5
GRK1-150-12	150 mm / 7,5 m	12 m	1,5
GRK1-150-16	150 mm / 7,5 m	16 m	1,5
GRK1-150-20	150 mm / 7,5 m	20 m	1,5
GRK1-150-24	150 mm / 7,5 m	24 m	1,5
GRK1-150-28	150 mm / 7,5 m	28 m	1,5

GRK1R



 Kit completi con canalina, aspiratore, un arrotolatore scorrevole con 7,5m tubo flessibile. Da completare con staffe, bocchetta e camino.

 Complete kits with rail, fan, one sliding reel with hose 7,5m long. To be completed with hanging brackets, nozzle and chimney.

 Kit complet avec rail, ventilateur d'extraction, un enrouleur coulissant avec 7,5 m de tuyau flexible. Kit à compléter avec les étriers de suspension, l'entonnoir, l'interrupteur électrique et le kit de refoulement extérieur.

 Satz mit Saugschlitzkanal, Ventilator und einem beweglichem Aufroller mit 7,5m Schlauch. Aufhängungen, Trichter und Ausblasrohrleitungen sind nicht inbegriffen.

 Kit completos con carril, aspirador, un enrollador deslizante con 7,5m de manguera. Para completar con estribos, boqueres y chimenea.





GRK1R	Ø / L.	L.	HP
GRK1R-75-8	1 x 75 mm / 7,5 m	8 m	1,0
GRK1R-75-12	1 x 75 mm / 7,5 m	12 m	1,0
GRK1R-75-16	1 x 75 mm / 7,5 m	16 m	1,0
GRK1R-75-20	1 x 75 mm / 7,5 m	20 m	1,0
GRK1R-75-24	1 x 75 mm / 7,5 m	24 m	1,0
GRK1R-100-8	1 x 100 mm / 7,5 m	8 m	1,0
GRK1R-100-12	1 x 100 mm / 7,5 m	12 m	1,0
GRK1R-100-16	1 x 100 mm / 7,5 m	16 m	1,0
GRK1R-100-20	1 x 100 mm / 7,5 m	20 m	1,0
GRK1R-100-24	1 x 100 mm / 7,5 m	24 m	1,0
GRK1R-125-12	1 x 125 mm / 7,5 m	12 m	1,5
GRK1R-125-16	1 x 125 mm / 7,5 m	16 m	1,5
GRK1R-125-20	1 x 125 mm / 7,5 m	20 m	1,5
GRK1R-125-24	1 x 125 mm / 7,5 m	24 m	1,5
GRK1R-125-28	1 x 125 mm / 7,5 m	28 m	1,5
GRK1R-150-12	1 x 150 mm / 7,5 m	12 m	1,5
GRK1R-150-16	1 x 150 mm / 7,5 m	16 m	1,5
GRK1R-150-20	1 x 150 mm / 7,5 m	20 m	1,5
GRK1R-150-24	1 x 150 mm / 7,5 m	24 m	1,5
GRK1R-150-28	1 x 150 mm / 7,5 m	28 m	1,5

GRK1GTL





GRK1GTL	Ø / L.	L.	HP
GRK1GTL-4	1 x 125 mm / 4,5 m	4 m	1,0
GRK1GTL-8	1 x 125 mm / 4,5 m	8 m	1,0
GRK1GTL-12	1 x 125 mm / 4,5 m	12 m	1,5
GRK1GTL-16	1 x 125 mm / 4,5 m	16 m	1,5

 Kit completi con canalina, aspiratore, un braccio GTL scorrevole. Da completare con staffe e camino.

 Complete kits with rail, fan, one sliding GTL touchless arm. To be completed with hanging brackets and chimney.

 Kit complet avec rail, ventilateur d'extraction, un bras sans contact GTL en version coulissante. Kit à compléter avec les étriers de suspension, l'interrupteur électrique et le kit de roulement extérieur.

 Satz mit Saugschlitzkanal, Ventilator und einem beweglichem GTL berührungslos Absaugarm. Aufhängungen und Ausblasrohrleitungen sind nicht inbegriffen.

 Kit completos con carril, aspirador, un brazo GTL deslizante sin contacto. Para completar con estribos y chimenea.

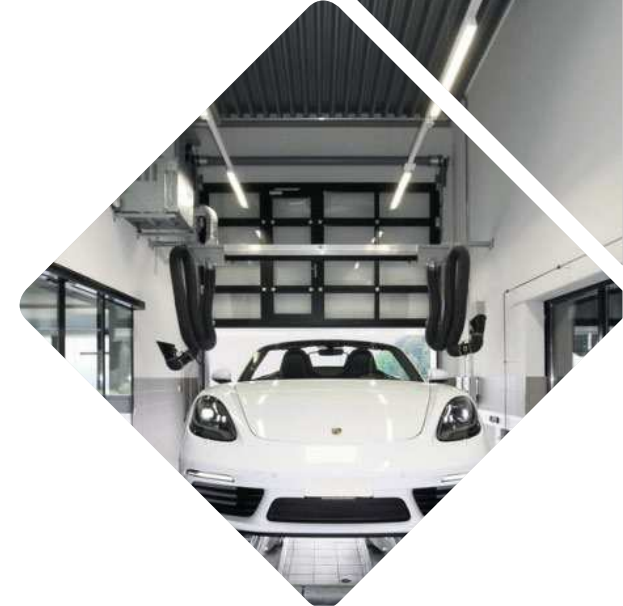

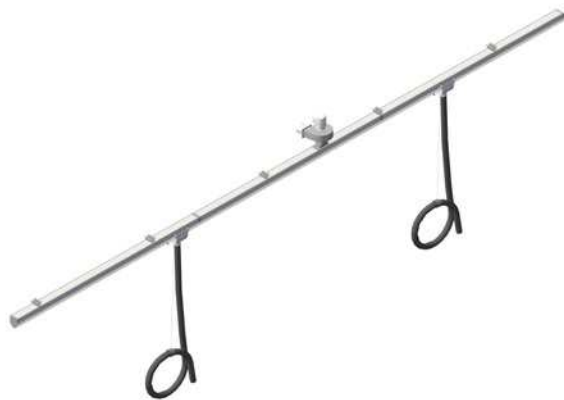

GRK2



 Kit completi con canalina, aspiratore, due carrelli scorrevoli con 7,5m tubo flessibile. Da completare con staffe, bocchetta e camino.

 Complete kits with rail, fan, two sliding carriages with hose 7,5m. To be completed with hanging brackets, nozzles and chimney.

 Kit complet avec rail, ventilateur d'extraction, deux chariots roulants avec 7.5 m de tuyau flexible. Kit à compléter avec les étriers de suspension, les entonnoirs, l'interrupteur électrique et le kit de refoulement extérieur.

 Satz mit Saugschlitzkanal, Ventilator, zwei Wagen mit 7,5m Schlauch und Seil mit Ring. Aufhängungen, Trichtern und Ausblasrohrleitungen sind nicht inbegriffen.

 Kit completos con carril, aspirador, dos carros deslizantes con 7,5m de manguera. Para completar con estribos, boqueras y chimenea.

GRK2	Ø / L.	L.	HP
GRK2-75-8	2 x 75 mm / 7,5 m	8 m	1,5
GRK2-75-12	2 x 75 mm / 7,5 m	12 m	1,5
GRK2-75-16	2 x 75 mm / 7,5 m	16 m	1,5
GRK2-75-20	2 x 75 mm / 7,5 m	20 m	1,5
GRK2-75-24	2 x 75 mm / 7,5 m	24 m	1,5
GRK2-100-8	2 x 100 mm / 7,5 m	8 m	1,5
GRK2-100-12	2 x 100 mm / 7,5 m	12 m	1,5
GRK2-100-16	2 x 100 mm / 7,5 m	16 m	1,5
GRK2-100-20	2 x 100 mm / 7,5 m	20 m	1,5
GRK2-100-24	2 x 100 mm / 7,5 m	24 m	1,5
GRK2-125-12	2 x 125 mm / 7,5 m	12 m	2
GRK2-125-16	2 x 125 mm / 7,5 m	16 m	2
GRK2-125-20	2 x 125 mm / 7,5 m	20 m	2
GRK2-125-24	2 x 125 mm / 7,5 m	24 m	2
GRK2-125-28	2 x 125 mm / 7,5 m	28 m	2
GRK2-150-12	2 x 150 mm / 7,5 m	12 m	2
GRK2-150-16	2 x 150 mm / 7,5 m	16 m	2
GRK2-150-20	2 x 150 mm / 7,5 m	20 m	2
GRK2-150-24	2 x 150 mm / 7,5 m	24 m	2
GRK2-150-28	2 x 150 mm / 7,5 m	28 m	2

GRK2R



 Kit completi con canalina, aspiratore, due arrotolatori scorrevoli con 7,5m tubo flessibile. Da completare con staffe, bocchetta e camino.

 Complete kits with rail, fan, two sliding reels with hose 7,5m long. To be completed with hanging brackets, nozzles and chimney.

 Kit complet avec rail, ventilateur d'extraction, deux enrouleurs coulissants avec 7,5 m de tuyau flexible. Kit à compléter avec les étriers de suspension, les entonnoirs, l'interrupteur électrique et le kit de refoulement extérieur.

 Satz mit Saugschlitzkanal, Ventilator und zwei beweglichem Aufrollern mit 7,5m Schlauch. Aufhängungen, Trichtern und Ausblasrohrleitungen sind nicht inbegriffen.

 Kit completos con carril, aspirador, tres enrolladores deslizantes con 7,5m de manguera. Para completar con estribos, boqueras y chimenea.

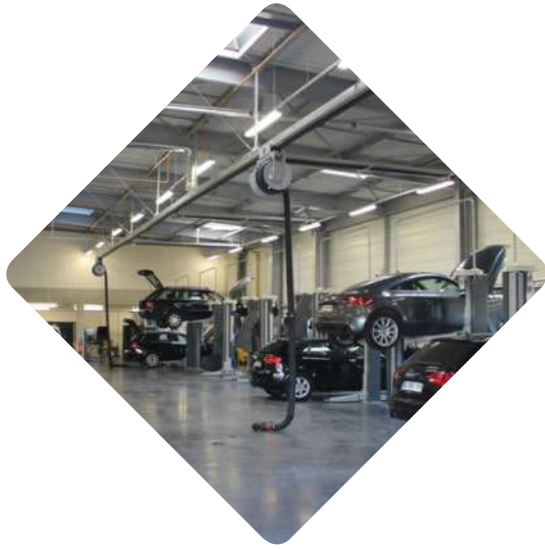



GRK2R	Ø / L.	L.	HP
GRK2R-75-8	2 x 75 mm / 7,5 m	8 m	1,5
GRK2R-75-12	2 x 75 mm / 7,5 m	12 m	1,5
GRK2R-75-16	2 x 75 mm / 7,5 m	16 m	1,5
GRK2R-75-20	2 x 75 mm / 7,5 m	20 m	1,5
GRK2R-75-24	2 x 75 mm / 7,5 m	24 m	1,5
GRK2R-100-8	2 x 100 mm / 7,5 m	8 m	1,5
GRK2R-100-12	2 x 100 mm / 7,5 m	12 m	1,5
GRK2R-100-16	2 x 100 mm / 7,5 m	16 m	1,5
GRK2R-100-20	2 x 100 mm / 7,5 m	20 m	1,5
GRK2R-100-24	2 x 100 mm / 7,5 m	24 m	1,5
GRK2R-125-12	2 x 125 mm / 7,5 m	12 m	2
GRK2R-125-16	2 x 125 mm / 7,5 m	16 m	2
GRK2R-125-20	2 x 125 mm / 7,5 m	20 m	2
GRK2R-125-24	2 x 125 mm / 7,5 m	24 m	2
GRK2R-125-28	2 x 125 mm / 7,5 m	28 m	2
GRK2R-150-12	2 x 150 mm / 7,5 m	12 m	3
GRK2R-150-16	2 x 150 mm / 7,5 m	16 m	3
GRK2R-150-20	2 x 150 mm / 7,5 m	20 m	3
GRK2R-150-24	2 x 150 mm / 7,5 m	24 m	3
GRK2R-150-28	2 x 150 mm / 7,5 m	28 m	3

GRK2GTL





GRK2GTL	Ø / L.	L.	HP
GRK2GTL-4	2 x 125 mm / 4,5 m	4 m	2,0
GRK2GTL-8	2 x 125 mm / 4,5 m	8 m	2,0
GRK2GTL-12	2 x 125 mm / 4,5 m	12 m	2,0
GRK2GTL-16	2 x 125 mm / 4,5 m	16 m	2,0
GRK2GTL-20	2 x 125 mm / 4,5 m	20 m	2,0

 Kit completi con canalina, aspiratore, due bracci GTL scorrevoli. Da completare con staffe e camino.

 Complete kits with rail, fan, two sliding GTL touchless arms. To be completed with hanging brackets and chimney.

 Kit complet avec rail, ventilateur d'extraction, deux bras sans contact GTL en version coullistante. Kit à compléter avec les étriers de suspension, l'interrupteur électrique et le kit de re-roulement extérieur.

 Satz mit Saugschlitzkanal, Ventilator und zwei bewegliche GTL berührungslos Absaugarme. Aufhängungen und Ausblasrohrleitungen sind nicht inbegriffen.

 Kit completos con carril, aspirador, dos brazos GTL deslizantes sin contacto. Para completar con estribos y chimenea.



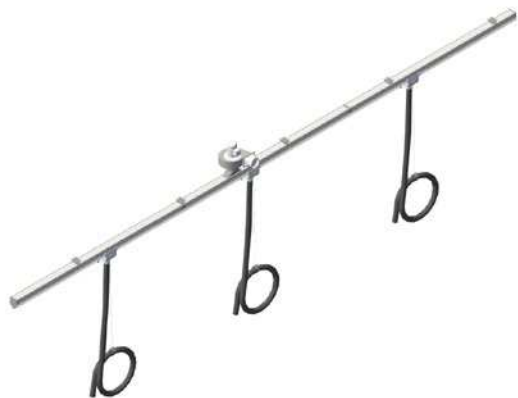

GRK3



 Kit completi con canalina, aspiratore, tre carrelli scorrevoli con 7,5m tubo flessibile. Da completare con staffe, bocchette e camino.

 Complete kits with rail, fan, three carriages with hose 7,5m. To be completed with hanging brackets, nozzles and chimney.

 Kit complet avec rail, ventilateur d'extraction, trois chariots roulants avec 7.5 m de tuyau flexible. Kit à compléter avec les étriers de suspension, les entonnoirs, l'interrupteur électrique et le kit de refoulement extérieur.

 Satz mit Saugschlitzkanal, Ventilator, drei Wagen mit 7,5m Schlauch und Seil mit Ring. Aufhängungen, Trichtern und Ausblasrohrleitungen sind nicht inbegriffen.

 Kit completos con carril, aspirador, tres carros deslizantes con 7,5m de manguera. Para completar con estribos, boqueras y chimenea.

GRK3	Ø / L.	L.	HP
GRK3-75-8	3 x 75 mm / 7,5 m	8 m	1,5
GRK3-75-12	3 x 75 mm / 7,5 m	12 m	1,5
GRK3-75-16	3 x 75 mm / 7,5 m	16 m	1,5
GRK3-75-20	3 x 75 mm / 7,5 m	20 m	1,5
GRK3-75-24	3 x 75 mm / 7,5 m	24 m	1,5
GRK3-100-8	3 x 100 mm / 7,5 m	8 m	2
GRK3-100-12	3 x 100 mm / 7,5 m	12 m	2
GRK3-100-16	3 x 100 mm / 7,5 m	16 m	2
GRK3-100-20	3 x 100 mm / 7,5 m	20 m	2
GRK3-100-24	3 x 100 mm / 7,5 m	24 m	2

GRK3R



 Kit completi con canalina, aspiratore, tre arrotolatori scorrevoli con 7,5m tubo flessibile. Da completare con staffe, bocchette e camino.

 Complete kits with rail, fan, three sliding reels with hose 7,5m long. To be completed with hanging brackets, nozzles and chimney.

 Kit complet avec rail, ventilateur d'extraction, trois enrouleurs coulissants avec 7,5 m de tuyau flexible. Kit à compléter avec les étriers de suspension, les entonnoirs, l'interrupteur électrique et le kit de refoulement extérieur.

 Satz mit Saugschlitzkanal, Ventilator und drei beweglichem Aufrollern mit 7,5m Schlauch. Aufhängungen, Trichtern und Ausblasrohrleitungen sind nicht inbegriffen.

 Kit completos con carril, aspirador, tres enrolladores deslizantes con 7,5m de manguera. Para completar con estribos, boqueras y chimenea.





GRK3GTL





GRK3R	Ø / L.	L.	HP
GRK3R-75-8	3 x 75 mm / 7,5 m	8 m	1,5
GRK3R-75-12	3 x 75 mm / 7,5 m	12 m	1,5
GRK3R-75-16	3 x 75 mm / 7,5 m	16 m	1,5
GRK3R-75-20	3 x 75 mm / 7,5 m	20 m	1,5
GRK3R-75-24	3 x 75 mm / 7,5 m	24 m	1,5
GRK3R-100-8	3 x 100 mm / 7,5 m	8 m	2
GRK3R-100-12	3 x 100 mm / 7,5 m	12 m	2
GRK3R-100-16	3 x 100 mm / 7,5 m	16 m	2
GRK3R-100-20	3 x 100 mm / 7,5 m	20 m	2
GRK3R-100-24	3 x 100 mm / 7,5 m	24 m	2

 Kit completi con canalina, aspiratore, due bracci GTL scorrevoli. Da completare con staffe e camino.

 Complete kits with rail, fan, two sliding GTL touchless arms. To be completed with hanging brackets and chimney.

 Kit complet avec rail, ventilateur d'extraction, trois bras sans contact GTL en version coulissante. Kit à compléter avec les étriers de suspension, l'interrupteur électrique et le kit de roulement extérieur.

 Satz mit Saugschlitzkanal, Ventilator und zwei bewegliche GTL Berührungslos Absaugarme. Aufhängungen und Ausblasrohrleitungen sind nicht inbegriffen.

 Kit completos con carril, aspirador, dos brazos GTL deslizantes sin contacto. Para completar con estribos y chimenea.





GRK3GTL	Ø / L.	L.	HP
GRK2GTL-4	3 x 125 mm / 4,5 m	4 m	2,0
GRK2GTL-8	3 x 125 mm / 4,5 m	8 m	2,0
GRK2GTL-12	3 x 125 mm / 4,5 m	12 m	3,0
GRK2GTL-16	3 x 125 mm / 4,5 m	16 m	3,0
GRK2GTL-20	3 x 125 mm / 4,5 m	20 m	3,0





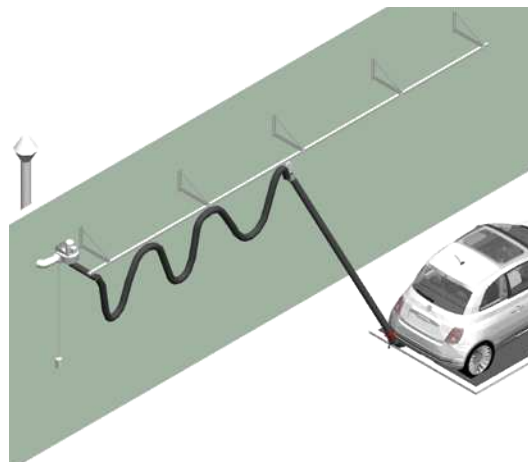

SNAKE



 Binario di scorrimento con tubo flessibile a festone dotato di bocchetta con pinza, bilanciere e ritorno automatico ad inizio linea.

 Complete kit for test lanes with steel slide line, hose, balancer, nozzle with grip, automatic return and fan.

 Kit complet VL avec profils de rail pour tuyau flexible équipé d'un entonnoir avec pince, équilibreur et retour automatique au début de la ligne.

 Satz für Prüfstraße mit Stahlprofil, Ventilator und Schlauch mit Balancer und Trichter für automatischen Rucklauf. Aufhängungen und Ausblasrohrleitungen sind nicht inbegriffen.

 Kit completos con perfil en acero, aspirador, balanceador y boquerel, con vuelta automática al comienzo de la línea. Para completar con estribos y chimenea.

GSNK	Ø	L.	HP
GSNK-100-8	100 mm	8 m	1,0
GSNK-100-12	100 mm	12 m	1,0
GSNK-100-16	100 mm	16 m	1,0
GSNK-100-20	100 mm	20 m	1,0
GSNK-150-16	150 mm	16 m	1,5
GSNK-150-20	150 mm	20 m	1,5
GSNK-150-24	150 mm	24 m	1,5



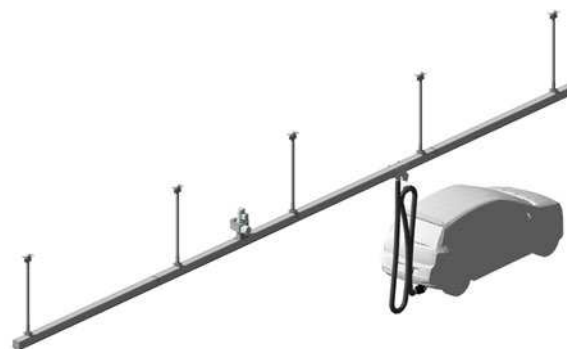

DRIVE KIT



 Kit per test line completo di canalina, aspiratore, carrello scorrevole con 7,5m tubo, bocchetta e bilanciere. Da completare con staffe e camino.

 Complete kit for test line with rail, fan, one carriage with hose 7,5m, nozzle and balancer. To be completed with hanging brackets and chimney.

 Kit d'aspiration avec rail pour centre de contrôle technique. Complet avec rail, ventilateur d'extraction, chariot couissant avec 7.5 m de tuyau flexible, entonnoir et équilibreur de rappel. Kit à compléter avec les étriers de suspension, l'interrupteur électrique et le kit de refoulement.

 Satz für Prüfstraße mit Saugschlitzkanal, Ventilator und einem Wagen mit 7,5m Schlauch mit Balancer und Trichter. Aufhängungen und Ausblasrohrleitungen sind nicht inbegriffen.

 Kit completos con carril, aspirador, carro con balanceador, 7,5 mt de manguera y boquerel con mordaza. Para completar con estribos y chimenea.

GDK	Ø / L.	L.	HP
GDK-100-8	100 mm / 7,5 m	8 m	1,0
GDK-100-12	100 mm / 7,5 m	12 m	1,0
GDK-100-16	100 mm / 7,5 m	16 m	1,0
GDK-100-20	100 mm / 7,5 m	20 m	1,0
GDK-150-16	150 mm / 7,5 m	16 m	1,5
GDK-150-20	150 mm / 7,5 m	20 m	1,5
GDK-150-24	150 mm / 7,5 m	24 m	1,5



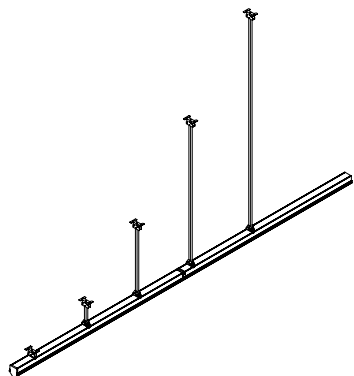

GSTS



GSTS	L.	↔
GSTS	10 cm	3,5 m / 4,0 m
GSTS-05	50 cm	3,5 m / 4,0 m
GSTS-1.5	150 cm	3,5 m / 4,0 m
GSTS-3	300 cm	3,5 m / 4,0 m
GSTS-4.5	450 cm	3,5 m / 4,0 m

 Staffe in acciaio verniciato con dispositivo di inclinazione per la sospensione a soffitto delle canaline aeree.

 Ceiling brackets in different lengths and inclination device for aluminum track support.

 Étriers de suspension pour rail en plusieurs longueurs avec dispositif d'inclinaison.

 Verschiedene Aufhängungen für Saugschlitzkanäle.

 Estribos en varias longitudes para sujetar el carril.

GSKT

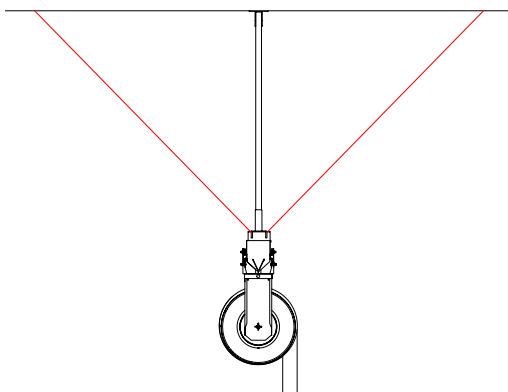

GSKT	L.	Ø
GSKT	2 X 5 m	3 mm

 Kit di tiranti in acciaio per stabilizzare lo staffaggio delle canaline aeree.

 Set of steel cables for balancing the rail supports.

 Set de cables en acier pour stabilisation des étriers.

 Stahlseil für Stabilisierung des Halterungs.

 Set de cables en acero para dar estabilidad a los estribos.

GKSTS

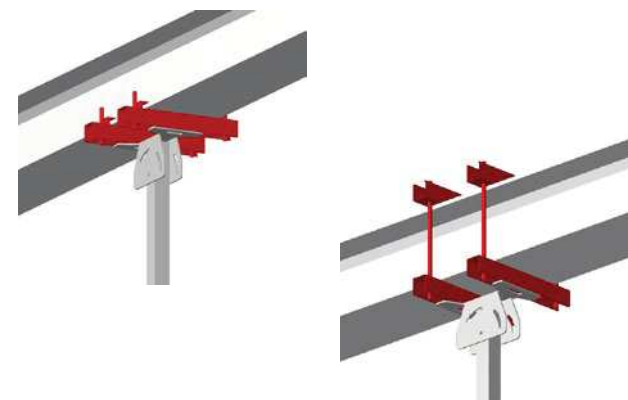

GKSTS	L. max	H max
GKSTS-IPE	400 mm	-
GKSTS-SB	400 mm	400 mm

 Sistema di aggancio a travi metalliche per staffe GSTS.

 H beam supporting elements for ceiling brackets GSTS.

 Raccords pour étriers de suspension GSTS.





 Adapter für Aufhängung GSTS, geeignet für IPE Träger.

 Enganche para estribos GSTS para sujetar el carril con vigas IPE.

GRK-KS





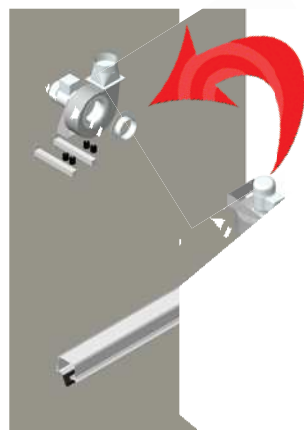

GRK-KS	L. TOT	NR. GSTS-3	NR. GSKT
GRK-KS8	8	3	3
GRK-KS12	12	4	4
GRK-KS16	16	5	5
GRK-KS20	20	6	6
GRK-KS24	24	7	7
GRK-KS28	28	8	8

-  Kit completo di staffaggio da 3 mt completo di tiranti in acciaio per canalina aerea.
-  Complete fixing kit with 3 mt hanging brackets and tightening rods for aluminum tracks.
-  Kit de fixation de 3 mt de longueur avec cables en acier pour rail en aluminium.
-  Aufhängungsatz 3 mt lang mit Stahlseilen für Stabilisierung des Halterungs.
-  Kit de estribos de 3 mt y cables en acero para sujetar carriles aereos de varias longitudes.

GRKTK





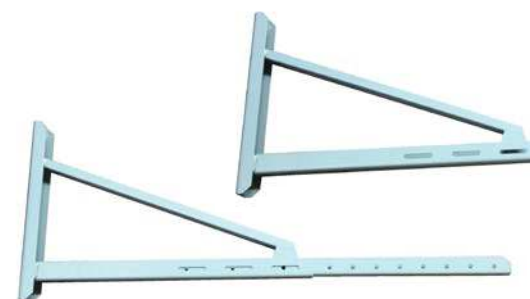

GRKTK	HP
GRKTK1-1.5	1 - 1,5
GRKTK2-3	2 - 3

-  Sistema di trasformazione con staffaggio a parete per aspiratore montato direttamente su canalina.
-  Transformation kit with wall bracket for fan installed directly on the rail.
-  Kit pour transformer le ventilateur installé directement au rail en version pour fixation au mur
-  Verwandlungssatz mit Wanskonsole für die Wandmontage des Ventilators auf dem Saugschlitzkanal eingebaut.
-  Kit de transformación con soporte a pared para extractor montado encima del carril.

GSTM



GSTM	L. max
GSTM0.5	0,5 m
GSTM1	0,5 m - 1 m
GSTM1.5	1,5 m
GSTM2	1,5 m - 2 m

-  Staffaggi murali fissi o regolabili per supporto canalina.
-  Wall brackets, fix or adjustable, for aluminum track support.
-  Étriers à fixation murale pour rail.
-  Wand-Aufhängung für Saugschlitzkanal.
-  Estribos a pared para sujetar el carril.